



## VS-Series Refrigerators

### VSR MODELS —

Stainless steel front,  
sides and interior.

**VSR-1**

**VSR-2**

**VSR-3**



VR-2

### Standard Features

- Stainless Steel Fronts, Sides and Interior for Durability
- Energy Efficient ABS Thermal Breakers Around Door Jamb
- Heavy-Duty Swivel Casters with Brakes
- Recessed Interior Lighting
- Exterior Dial Thermometer
- Lifetime Self-Closing Camlift Hinges with 110° Stay-Open Feature
- Self-Adjusting Magnetic Door Gaskets
- Heavy-Duty Cylinder Locks
- Durable and Energy Efficient ABS Interior Door Liners
- Door Opening Accepts 20" Wide Pan(s)
- Epoxy Coated Shelves Adjustable on 1" Centers
- Automatic Non-Electric Condensate Disposal System
- Environmentally Friendly R-134a Refrigerant
- Anti-Corrosion Coated Evaporator Coil
- 10' Cord and Plug Connected
- Interior Light Switch Mounted in the Hinge

### Optional Features:

- Rod Type Pan Slides
- Stainless Steel Angle Type Pan Slides
- Adjustable 6" Legs
- Two Half Doors in Place of One Full Length Door
- Solar Digital Thermometer

### Cabinet:

Victory's Value Packed VS-Series refrigerators are constructed of heavy gauge, polished stainless steel to maintain an attractive appearance and maximum durability for years to come.

Interiors feature coved corners that are easy to clean and maintain. An average of over 2½ inches of foamed-in-place polyurethane insulation throughout the cabinet assures the food storage compartment remains well insulated promoting energy efficiency. The bottom of the storage compartment is made of heavy gauge metal with 3½ inches of polyurethane insulation for exceptional strength. Interior lighting is recessed.

### Doors:

The self-closing doors stay open at 110° facilitating loading. Each door has a cylinder lock. Interior lighting is controlled automatically by a switch mounted in the hinge.

### Shelving:

Heavy-duty, epoxy coated steel shelves are mounted on pilaster strips and are adjustable on 1" increments. Wide door openings accommodate two 12" x 20", or one 18" x 26", or one 14" x 18" pans/trays per level.

### Refrigeration:

All components of the self-contained refrigeration system are mounted on top of the cabinet. The air circulating fans and the forced convection cooling coil are contained in an insulated housing separate from the product zone allowing for maximum food storage capacity. All condensate water is disposed of automatically by the energy efficient nonelectric condensate evaporator, no plumbing is required.

The R-134a refrigerant used is environmentally friendly.

Approvals:



Victory Refrigeration specification sheets are available online at [www.victory-refrig.com](http://www.victory-refrig.com).

CHARACTERISTICS	ONE SECTION Reach-In	TWO SECTION Reach-In	THREE SECTION Reach-In
Width, Overall	26 1/2	52 1/8	77 3/4
Depth, Overall (incl. handles)	33 1/4	33 1/4	33 1/4
Height, Overall (incl. adj. legs)	84	84	84
Depth, Open Door 90°	56 3/4	56 3/4	56 3/4
Clear Door Opening, Width	21 1/2	21 1/2	21 1/2
Clear Full Door Opening, Height	54 5/8	54 5/8	54 5/8
Clear Half Door Opening, Height	25 1/4	25 1/4	25 1/4
Capacity Net (cubic feet)	20.4	43.4	66.4
No. of Full Doors	1	2	3
No. of Half Doors	2	4	6
No. of Shelves	3	6	9
Shelf Area (square feet)	17.1	36.0	54.2
Cabinet Voltage	115/60/1	115/60/1	115/60/1
Feed Wires	2	2	2
Condensing Unit Voltage	115/60/1	115/60/1	115/60/1
Condensing Unit Size (HP)	1/3	1/3	1/2
Total Amperes	5.5	8.2	10.6
Plug, NEMA	5-15P	5-15P	5-15P

Crated dim. & wts.	Ht.	Width	Depth	Cu. Ft.	Lbs.
One Section	84 1/4	36	43	82.2	305
Two Section	84 1/4	60	43	143.3	435
Three Section	84 1/4	90	43	204.4	585

Dimensional tolerance ± 1/4" Metric dimensions (MM)

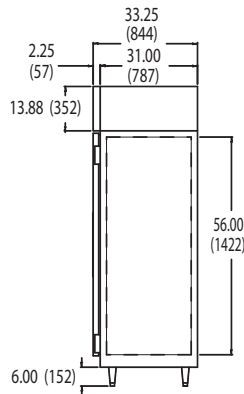

VSR-1, VSR-2, VSR-3 SIDE VIEW

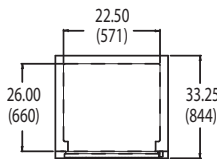

VSR-1 TOP VIEW

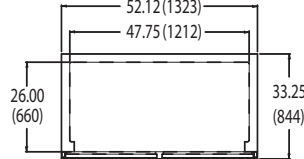

VSR-2 TOP VIEW

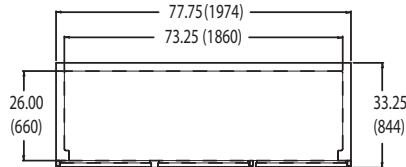

VSR-3 TOP VIEW

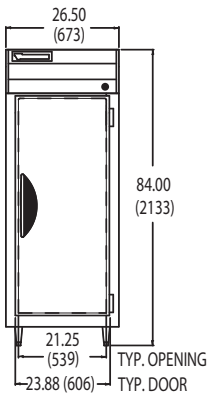

VSR-1 FRONT VIEW

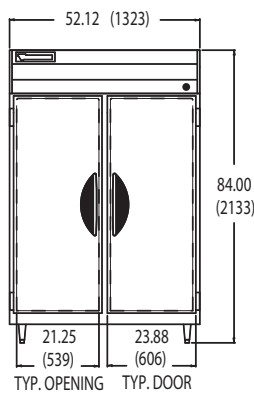

VSR-2 FRONT VIEW

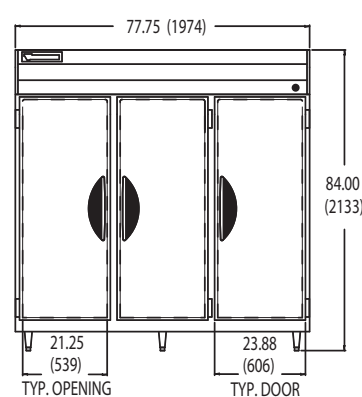

VSR-3 FRONT VIEW

**NOTE:** If cabinet is located directly against wall an all around clearance of 2" is required, and a minimum clearance of 10" under ceiling.

We reserve the right to change specifications and product design without notice. Such revisions do not entitle the buyer to corresponding changes, improvements, additions or replacements for previously purchased equipment.

Continuous product development may necessitate specification changes and design without notice.



Victory participates in the KCL CADalog, the most current source of CAD symbols for foodservice designers worldwide. Symbols include standard equipment in plan, side, front and 3-D views, layered for FEDA/FCSI recommended guidelines.