



NE-1064

1000 Watt* Commercial Microwave Oven

- Stainless Steel Cabinet and Cavity
- 1000* Watts of Power
- Capacity: 0.8 cubic feet
- “Grab & Go” Door Handle
- Bottom Energy Feed
- Braille Keypad
- Cord Length 5'5"
- Chef Technical Support
- Fits One Half-size 6"-Tall Pan with Cover
- 10 Programmable Memory pads; 20 Memory Capability
- 6 Power Levels
- 2- and 3-stage cooking
- Programmable and Manual Operations
- Program List/Cycle Counter
- Self Diagnostics
- 99:99 Minute Capacity
- Interior Oven Light
- See-Through Oven Door
- Touch Control Keypad
- Anti-Theft Equipped
- Will Ship via UPS

Technical Specifications

Power source: 120V, 60Hz, Single phase

Receptacle required: NEMA 5-15 R or
NEMA 5-20 R



Frequency: 2,450MHz

Required power: 13.4A

Output: 1000 watts*

Outer dimensions: 20 $\frac{1}{8}$ " w x 16 $\frac{3}{8}$ " d x 12" h

Cavity dimensions: 13" w x 13" d x 8 $\frac{3}{16}$ " h

Net weight: 34 lbs.

Shipping weight: 39 lbs.

Shipping box size: 24" w x 18 $\frac{1}{2}$ " d x 14 $\frac{3}{4}$ " h, 3.8 cu. ft.

Timer: 99 Minutes, 99 Seconds

Memory Capability: 20 Programs

To specify a Panasonic Commercial Microwave Oven

The NE-1064 Commercial Microwave Oven meets or exceeds all safety performance and sanitation standards set for commercial food service microwave ovens by UL, DHHS, FCC and NSF.

Plus, oven shall have output power 1000 Watts*, stainless steel cabinet and cavity, bottom energy feed, 10 programmable memory pads, Braille keypad, 20-memory capability, double quantity key, 6 power levels, 2- and 3-stage cooking, programmable lock, unique “quick pick” preset times and self-diagnostics, Chef/Test Kitchen technical support and 3 year limited warranty.

**I.E.C. 60705 Test Procedure. Specifications subject to change without notice.*

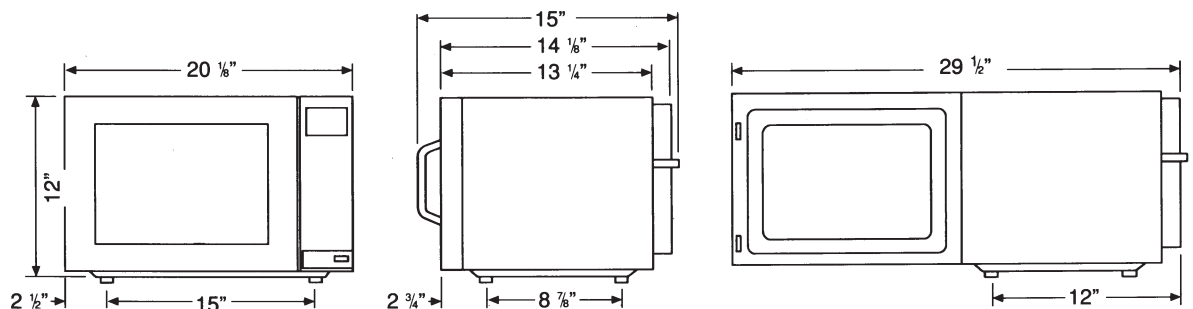

Panasonic
ideas for life

Panasonic Appliance & Commercial Group

Division of Matsushita Electric Corporation of America

Executive Offices:

One Panasonic Way, Panazip 4A-1, Secaucus, NJ 07094

Toll Free: 1-888-350-9590

www.panasonic.com/cmo