

KM-515M_H

SLIM-LINE MODULAR CRESCENT CUBER

Item # _____

Project: _____

Qty: _____

*AutoCad available on KCL

KM-515M_H

6/11

Item # 13217

CUBER DIMENSIONS

W x D x H

KM-515M_H

22 x 27^{3/8} x 30^{5/16}

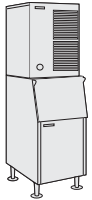

B-300

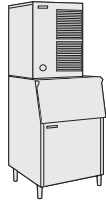

B-500

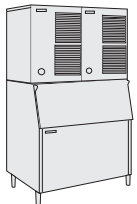

B-700

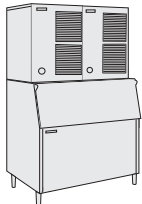

B-800

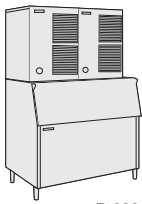

B-900

Also available on Large Bins:

B-1150SS

B-1300SS

B-1500SS

B-1650SS



KM-515MAH

Air-Cooled



Shown on an optional
B-300

KM-515MWH

Water-Cooled

KM-515MRH

Remote Air-Cooled

- Up to 501 lbs. of ice production per 24 hours
- Durable stainless steel exterior
- Individual crescent cube
- Protected by *H-GUARD Plus* Antimicrobial Agent 
- CycleSaver® Design 
- EverCheck® alert system 
- Stainless steel evaporator
- Mount two units side-by-side, in only 44" of floor space, for 1,002 lbs. per 24 hours
- Removable air filters (Air-cooled models only)
- R-404A Refrigerant
- * The KM-515MRH is ENERGY STAR qualified.

Warranty

Valid in United States, Canada, Puerto Rico, & U.S. Territories. Contact factory for warranty in other countries.

Three Year - Parts & Labor on entire machine.

Five Year - Parts & Labor on: Evaporator.

Five Year - Parts on: Compressor, air-cooled condenser coil.



ISO 9001-5:2008

© HOSHIZAKI AMERICA, INC.

618 Hwy. 74 S., Peachtree City, GA 30269

TEL 1-800-438-6087

FAX 1-800-345-1325

www.hoshizaki.com



SLIM-LINE MODULAR CRESCENT CUBER

DIMENSIONS
W x D x H
KM-515M_H
22 x 27^{3/8} x 30^{5/16}

- Air-cooled
- Water-cooled
- Remote Air-cooled

AIR-COOLED

Water Temp ° F.	50°	70°	90°
Air Temp ° F.	70°	482	447
	80°	486	416
	90°	482	435

WATER-COOLED

Water Temp ° F.	50°	70°	90°
Air Temp ° F.	70°	493	465
	80°	494	445
	90°	493	475

REMOTE AIR-COOLED

Water Temp ° F.	50°	70°	90°
Air Temp ° F.	70°	491	443
	80°	482	417
	90°	480	452

UTILITY CONSUMPTION

Model Number	Ice Production Per Cycle		KWH per 100 LBS. 90/70	Potable Water Gal. per 100 lbs.	Condenser Water Gal. per 100 lbs.
	Lbs.	Cubes			
KM-515MAH	10.2	480	6.0	22.8	N/A
KM-515MWH	10.3	480	4.8	21.5	115
KM-515MRH	10.3	480	5.8	20.8	N/A

SPECIFICATIONS

Model Number	Condenser	Amperage	Min. Circuit Ampacity	Shipping Weight
KM-515MAH	Air-Cooled	11.7	20	175 lbs.
KM-515MWH	Water-Cooled	9.6	20	175 lbs.
KM-515MRH	Remote Air-Cooled	11.3	20	175 lbs.

STORAGE BINS

Model Number	Application Capacity	ARI-Rated Capacity
B-300	300 lbs.	260 lbs.
B-500	500 lbs.	360 lbs.
B-700	700 lbs.	550 lbs.
B-800	800 lbs.	600 lbs.
B-900	900 lbs.	660 lbs.
B-1150	1150 lbs.	N/A
B-1300	1275 lbs.	N/A
B-1500	1490 lbs.	N/A
B-1650	1605 lbs.	N/A

ELECTRICAL & PLUMBING/KM-515M_H

- 115V/60/1
- 20 Amp Max Fuse/HACR Breaker Size
- 1/2" FPT water inlet
- 3/4" FPT water drain



BSL09001-15C114901

© HOSHIZAKI AMERICA, INC.

618 Hwy. 74 S., Peachtree City, GA 30269

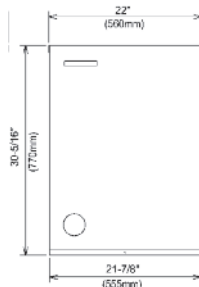

FRONT VIEW

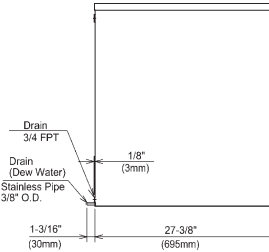

SIDE VIEW

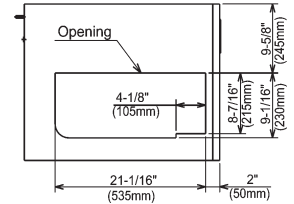

ICE DROP ZONE

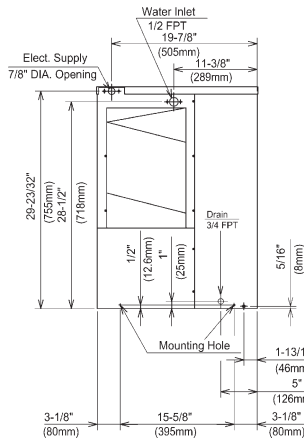

AIR-COOLED UNIT

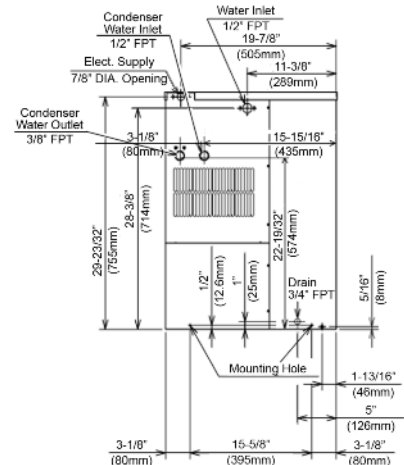

WATER-COOLED UNIT

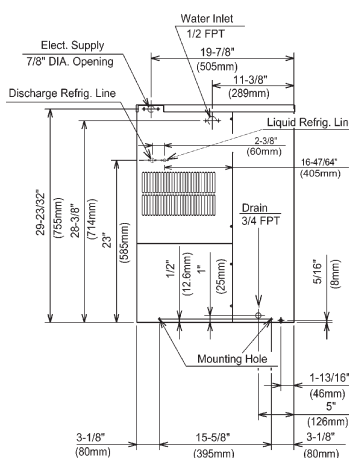

REMOTE AIR-COOLED UNIT

URC-5F Remote Condenser (Sold Separately)
For Use with KM-515MRH

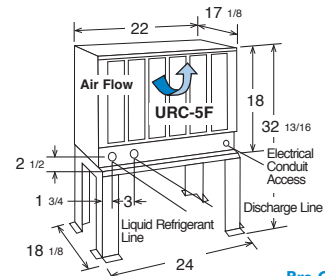

Pre-Charged Tubing Kits
(Sold Separately)
20' R404-2046-2
35' R404-3546-2



Voltage supply for the URC Remote Condenser is supplied from the Ice Maker. No additional circuit is required.

OPERATING LIMITS

- Ambient Temp Range 45 - 100°F
- Water Temp Range 45 - 90°F
- Water Pressure 10 - 113psig
- Voltage Range 104 - 127V

OPERATING LIMITS/URC-5F

- Ambient Temp Range -20°F - +122°F
- Voltage Range 104 - 127V

SERVICE

- Panels easily removed and all components accessible for service.
- Removable/cleanable air filters. (Air-cooled models only)

TEL 1-800-438-6087

FAX 1-800-345-1325

www.hoshizaki.com

Printed in U.S.A.

